



60 cm City One Glass built-in oven

Multiprogram

1FCOPN

Description

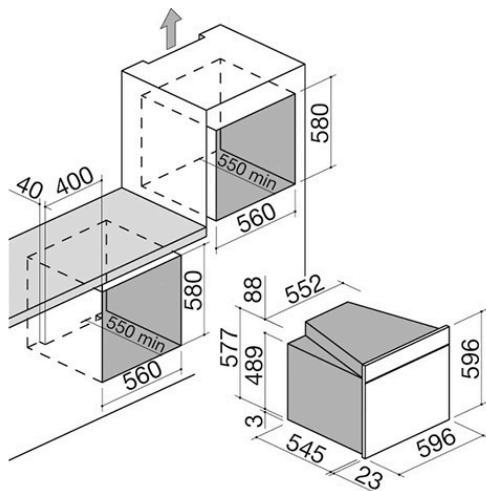

- 8 manual functions
- + rapid defrost function
- maximum temperature: 270 °C
- capacity: 66 litres
- electronic digital start/stop cooking programmer and timer
- features: Easy Clean oven lining, extractable and removable door with triple heat-reflecting glass, Soft-Close hinges, tangential cooling fan, drop-down grill, 2 rear lights, side racks
- equipment: 1 deep Easy Clean enamelled steel drip tray, 1 Easy Clean enamelled steel drip tray, 1 steel rack
- maximum absorbed power: 2.7 kW

SEE OTHER AVAILABLE DESIGNS:



1FCOPI



1FCOMI



Plus

Detailed Features

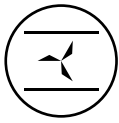

Convection functions

Multifunction electric oven with fan-assisted air circulation, distributing heat evenly for fast and uniform cooking.



Energy rating A

All 60 and 90 cm ovens by Barazza belong to energy class A: maximum efficiency to optimise performance and reduce energy consumption. Barazza operates according to an eco-sustainability principle, favouring future generations.



66-litre oven capacity

The large cavities of Barazza ovens help reduce cooking times and energy consumption.



Easy Clean oven interior

All Barazza ovens feature an Easy Clean interior, a surface treatment that facilitates and speeds up cleaning.



Soft-Close hinges

Soft-Close hinges are a mechanical device that slows down and cushions the final stage of door closing.

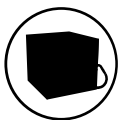

Cool door



Barazza oven doors, removable and dismantable, feature triple or quadruple glass with heat-reflective crystals that prevent the outer surface from overheating.



Functions

Main Functions



Top + bottom heating element

Suitable for any type of dish, but particularly effective for baking cakes, pizzas and soufflés, and for roasting.



Bottom heating element

Suitable for baking biscuits, tarts and pies, or for heating up dishes before serving them.



Top heating element

Ideal for lightly browning dishes, especially lasagne and other baked pasta dishes, or vegetable soufflés.

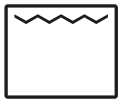

Traditional grill

This is particularly useful for cooking slim cuts of meat and for making toast and crostini.



Grill + fan

Suitable for cooking thicker cuts of meat or particularly large dishes, it is good for quickly reducing the excess humidity in food.



Top and bottom heating elements + fan

Ideal for fast, uniform cooking, this is particularly suitable for baking biscuits and cakes.



Circular and bottom heating elements + fan

It lets you cook similar dishes at the same time, arranged on shelves, up to a maximum of three levels.

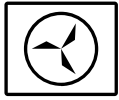

Circular heating element + fan

It lets you cook similar dishes at the same time, arranged on shelves, up to a maximum of three levels.

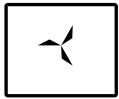

Rapid defrost function

By setting the thermostat at 0 °C and selecting any fan function, the oven can speed up defrosting.



Installations

Installation Method

energy
rating

A

Rating A



RATING A Maximum efficiency with reduced consumption. Class A ensures high performance while fully respecting the environment and energy savings.



Related Accessories



1PPI

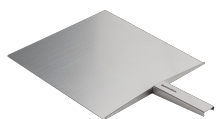

1PPZ



1CG6



1CFFA

Related Products



1FCOPI



1FCOMI