

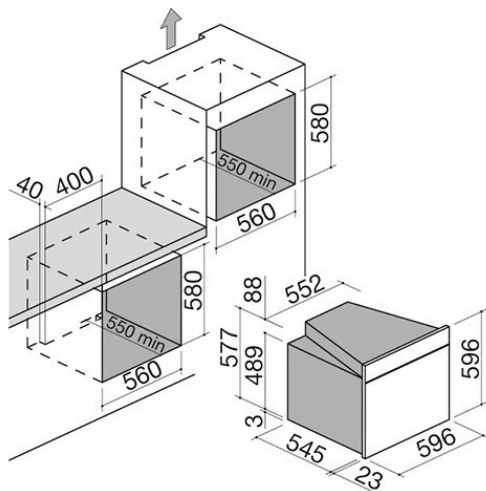

# 60 cm Icon Glass built-in oven

## Touch Control + knobs

1FEVGP



### Description

- Zefiro sanitisation system
- 13 manual functions
- 16 automatic cooking programs
- + Cleaning
- 30 customisable cooking programs
- Veggy mode
- maximum temperature: 250 °C
- capacity: 66 litres
- Touch control multilingual digital programmer + knobs
- features: front controls, knobs and handle in Soft-Touch finish, Easy Clean oven lining, extractable and removable door with triple heat-reflecting glass, Soft-Close hinges, tangential cooling fan, drop-down grill, 2 rear lights, side racks
- equipment: 1 deep Easy Clean enamelled steel drip tray, 1 Easy Clean enamelled steel drip tray,
- 2 pairs of telescopic oven rails
- safety devices: safety switch-off, electronic child-safety lock
- maximum absorbed power: 2.7 kW

SEE OTHER AVAILABLE DESIGNS:



1FEVEPN



1FEVSP



# Plus

## Detailed Features



Touch Control display

The high-definition Touch Control display offers precise, simple, and intuitive viewing of the various cooking and oven settings.



Automatic cooking programs ovens

Automatic cooking programs allow you to achieve perfect results simply by selecting the desired recipe and placing the food in a cold oven.



Child safety lock

Prevents accidental changes to the hob settings, particularly by children.

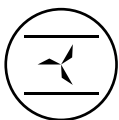

Convection functions

Multifunction electric oven with fan-assisted air circulation, distributing heat evenly for fast and uniform cooking.

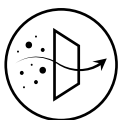

Zefiro

The world's first system capable of transforming a built-in oven into a true air sanitiser, improving the quality of the kitchen environment.



Veggy mode



Designed for those who do not consume meat or fish, this mode excludes all automatic cooking programs based on animal proteins.



Energy rating A

All 60 and 90 cm ovens by Barazza belong to energy class A: maximum efficiency to optimise performance and reduce energy consumption. Barazza operates according to an eco-sustainability principle, favouring future generations.



Soft-Touch finish elements

Elegant to the eye and pleasant to the touch, the Soft-Touch finish features on various product lines, covering knobs, handles and control panels.



66-litre oven capacity

The large cavities of Barazza ovens help reduce cooking times and energy consumption.



Easy Clean oven interior

All Barazza ovens feature an Easy Clean interior, a surface treatment that facilitates and speeds up cleaning.

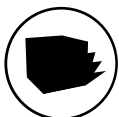

Soft-Close hinges

Soft-Close hinges are a mechanical device that slows down and cushions the final stage of door closing.

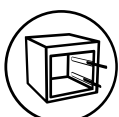

Telescopic rails



Telescopic rail sets make it easier and safer to insert and remove trays.



Cool door

Barazza oven doors, removable and dismountable, feature triple or quadruple glass with heat-reflective crystals that prevent the outer surface from overheating.

Zefiro



# Functions

## Main Functions

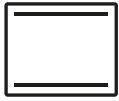

Top + bottom heating element

Suitable for any type of dish, but particularly effective for baking cakes, pizzas and soufflés, and for roasting.



Bottom heating element

Suitable for baking biscuits, tarts and pies, or for heating up dishes before serving them.



Top heating element

Ideal for lightly browning dishes, especially lasagne and other baked pasta dishes, or vegetable soufflés.

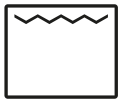

Traditional grill

This is particularly useful for cooking slim cuts of meat and for making toast and crostini.



Maxi Grill

Using the top heating element and the grill at the same time allows strong heat to be concentrated on the surface of the food, crisping it up more quickly.



Grill + fan

Suitable for cooking thicker cuts of meat or particularly large dishes, it is good for quickly reducing the excess humidity in food.

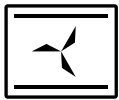

Top and bottom heating elements + fan

Ideal for fast, uniform cooking, this is particularly suitable for baking biscuits and cakes.



Circular and bottom heating elements + fan

It lets you cook similar dishes at the same time, arranged on shelves, up to a maximum of three levels.



Defrosting

This lets you defrost dishes gently, without any detrimental effect.



Keep warm

Keeping a constant temperature of 80, 100, 120 °C allows food to stay hot whilst waiting to be served.



Eco

This allows different types of dishes to be cooked with lower consumption of electricity.

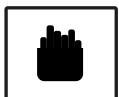

Air frying

For crispy and golden brown foods, requiring less cooking oil for a light and delicious result.



Customisable cooking programs

60 cm Touch Screen and Touch Control ovens can record up to a maximum of 30 personalised recipes, including multistage ones, from the menu that appears at the end of a manual cooking cycle.

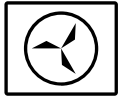

Circular heating element + fan

It lets you cook similar dishes at the same time, arranged on shelves, up to a maximum of three levels.



# Installations

## Installation Method

energy  
rating

A

Rating A



RATING A Maximum efficiency with reduced consumption. Class A ensures high performance while fully respecting the environment and energy savings.



## Related Accessories



1PPI



1PPZ



1CFFA

## Related Products



1FEVEPN



1FEVSP



1FEVEMCN



1FEVSMC



1FEVGMC