



# Icon Steel built-in compact combi-microwave oven

## Touch Control + knobs

1FEVSMC



### Description

- 17 manual functions
- 20 automatic cooking programs
- 5 automatic defrosting programs
- Veggy mode
- microwave functions up to 1000 W
- maximum temperature: 250 °C
- capacity: 40 litres
- Touch control multilingual digital programmer + knobs
- features: front controls, knobs and handle in Soft-Touch finish,
- Easy Clean oven lining, extractable and removable door with triple
- heat-reflecting glass, Soft-Close hinges, tangential cooling fan,
- internal light, side racks
- equipment: 1 Pirex baking tray,
- 1 steel rack
- safety devices: electronic child-safety lock
- maximum absorbed power: 3.5 kW

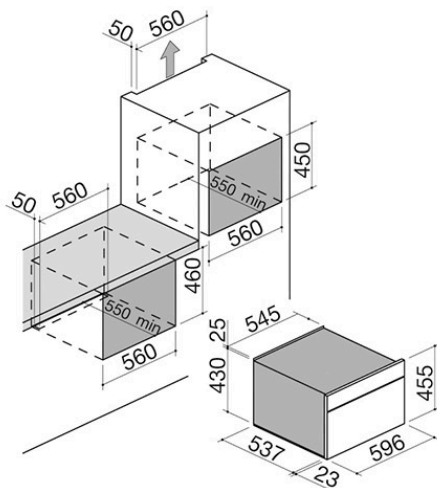

SEE OTHER AVAILABLE DESIGNS:



1FEVEMCN



1FEVGMC



# Plus

## Detailed Features



Touch Control display

The high-definition Touch Control display offers precise, simple, and intuitive viewing of the various cooking and oven settings.



Automatic cooking programs ovens

Automatic cooking programs allow you to achieve perfect results simply by selecting the desired recipe and placing the food in a cold oven.



Child safety lock

Prevents accidental changes to the hob settings, particularly by children.

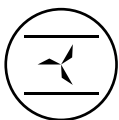

Convection functions

Multifunction electric oven with fan-assisted air circulation, distributing heat evenly for fast and uniform cooking.



Veggy mode

Designed for those who do not consume meat or fish, this mode excludes all automatic cooking programs based on animal proteins.



Soft-Touch finish elements



Elegant to the eye and pleasant to the touch, the Soft-Touch finish features on various product lines, covering knobs, handles and control panels.



Easy Clean oven interior

All Barazza ovens feature an Easy Clean interior, a surface treatment that facilitates and speeds up cleaning.



Soft-Close hinges

Soft-Close hinges are a mechanical device that slows down and cushions the final stage of door closing.

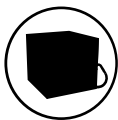

Cool door

Barazza oven doors, removable and dismountable, feature triple or quadruple glass with heat-reflective crystals that prevent the outer surface from overheating.



Module height 45

The ovens and coordinated products are available in various heights to adapt perfectly to any installation and configuration need.



40-litre cavity capacity

The large cavities of Barazza ovens help reduce cooking times and energy consumption.

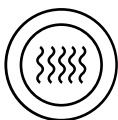

Microwave functions



Barazza's microwave ovens complete the range with easy-to-use technology and immediate performance, paired with an aesthetic of pure design in stainless steel or black finish. Highly functional and versatile, they offer quick cooking and flexible installation options.



# Functions

## Main Functions



Top + bottom heating element

Suitable for any type of dish, but particularly effective for baking cakes, pizzas and soufflés, and for roasting.



Bottom heating element

Suitable for baking biscuits, tarts and pies, or for heating up dishes before serving them.

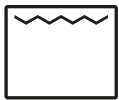

Traditional grill

This is particularly useful for cooking slim cuts of meat and for making toast and crostini.



Maxi Grill

Using the top heating element and the grill at the same time allows strong heat to be concentrated on the surface of the food, crisping it up more quickly.



Grill + fan

Suitable for cooking thicker cuts of meat or particularly large dishes, it is good for quickly reducing the excess humidity in food.



Top and bottom heating elements + fan

Ideal for fast, uniform cooking, this is particularly suitable for baking biscuits and cakes.



Circular and bottom heating elements + fan

It lets you cook similar dishes at the same time, arranged on shelves, up to a maximum of three levels.



Defrosting

This lets you defrost dishes gently, without any detrimental effect.



Eco

This allows different types of dishes to be cooked with lower consumption of electricity.



Automatic cooking programs

60 cm Touch Screen and Touch Control ovens offer a set of 16 automatic programs, with the option of setting the weight and an indication of the level at which to place the food.

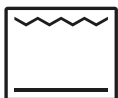

Grill + bottom heating element

The simultaneous use of the grill and bottom heating element lets you cook and brown foods at the same time.



Slow cooking

Ideal for dishes, especially meat-based ones, that need long cooking at a low temperature.



Microwave

Microwave cooking at adjustable power levels, to 1000W, which means cooking and defrosting of food can be significantly speeded up.

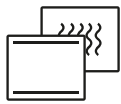

Combi-microwave + top and bottom heating elements

Suitable for any type of dish, this allows the traditional process of cooking in a conventional oven to be speeded up.

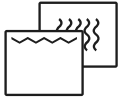

Combi-microwave + grill

The addition of the microwave to the traditional grill lets dishes get even crispier. Ideal for preparing lasagne, potatoes, roasts and different types of soufflé.

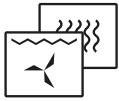

Combi-microwave + grill + fan

Ideal for speeding up the cooking process of thicker cuts of meat or particularly large dishes.

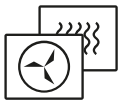

Combi-microwave + circular heating element + fan

This helps speed up the preparation process of dishes that are similar to each other and arranged on different shelves, guaranteeing rapid, uniform cooking.



Circular heating element + fan

It lets you cook similar dishes at the same time, arranged on shelves, up to a maximum of three levels.



## Related Accessories



1PPI



1PPZ



1CFFA

## Related Products



1FEVEPN



1FEVSP



1FEVGP



1FEVEMCN



1FEVGMC