



90 cm Icon XL Exclusive built-in oven

Multiprogram

1FICNE9EN

Description



- 90x60 cm
- 8 manual functions
- maximum temperature: 250 °C
- capacity: 120 litres
- electronic digital start/stop
- cooking programmer and timer
- features: front controls, knobs and handle in Soft-Touch finish, extractable and removable door with triple heat-reflecting glass, Easy Clean oven lining, dark grey glass, Soft-Close hinges, tangential cooling fan, triple convection fan, 2 rear lights, side racks
- equipment: 1 Easy Clean enamelled steel drip tray, 1 steel rack, rotisserie
- safety devices: safety switch-off
- maximum absorbed power: 3.15 kW

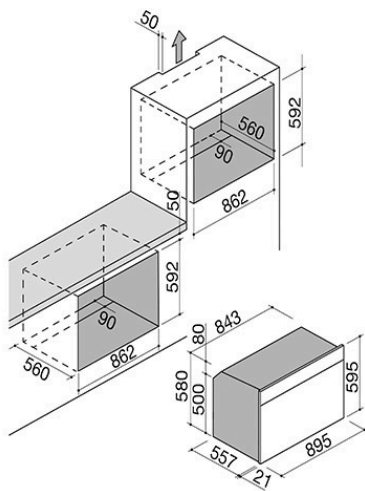

SEE OTHER AVAILABLE DESIGNS:



1FICN9EI



1FICN9E



Plus

Detailed Features

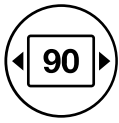

Module width 90

Ovens and matching elements are available in three width options: 60, 75 and 90 cm, to perfectly meet any space or design requirements.



Convection functions

Multifunction electric oven with fan-assisted air circulation, distributing heat evenly for fast and uniform cooking.



Energy rating A

All 60 and 90 cm ovens by Barazza belong to energy class A: maximum efficiency to optimise performance and reduce energy consumption. Barazza operates according to an eco-sustainability principle, favouring future generations.



Soft-Touch finish elements

Elegant to the eye and pleasant to the touch, the Soft-Touch finish features on various product lines, covering knobs, handles and control panels.



Easy Clean oven interior

All Barazza ovens feature an Easy Clean interior, a surface treatment that facilitates and speeds up cleaning.



Soft-Close hinges

Soft-Close hinges are a mechanical device that slows down and cushions the final stage of door closing.

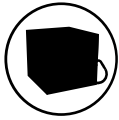

Cool door

Barazza oven doors, removable and dismountable, feature triple or quadruple glass with heat-reflective crystals that prevent the outer surface from overheating.

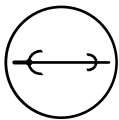

Rotisserie

When the rotisserie is inserted into the oven and a compatible cooking function is selected, it is automatically activated to rotate.



Module 60 height

The ovens and coordinated products are available in various heights to adapt perfectly to any installation and configuration need.



120-litre cavity capacity

The large oven cavities help optimise cooking times, resulting in energy savings.



Functions

Main Functions



Top + bottom heating element

Suitable for any type of dish, but particularly effective for baking cakes, pizzas and soufflés, and for roasting.



Bottom heating element

Suitable for baking biscuits, tarts and pies, or for heating up dishes before serving them.

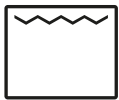

Traditional grill

This is particularly useful for cooking slim cuts of meat and for making toast and crostini.



Maxi Grill

Using the top heating element and the grill at the same time allows strong heat to be concentrated on the surface of the food, crisping it up more quickly.



Top and bottom heating elements + fan

Ideal for fast, uniform cooking, this is particularly suitable for baking biscuits and cakes.



Grill + fan + rotisserie

Suitable for cooking thicker cuts of meat or particularly large dishes, it is good for quickly reducing the excess humidity in food.

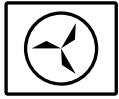

Circular heating element + fan

It lets you cook similar dishes at the same time, arranged on shelves, up to a maximum of three levels.



Rapid defrost function

By setting the thermostat at 0 °C and selecting any fan function, the oven can speed up defrosting.



Installations

Installation Method

energy
rating

A

Rating A



RATING A Maximum efficiency with reduced consumption. Class A ensures high performance while fully respecting the environment and energy savings.



Related Accessories



1PPI

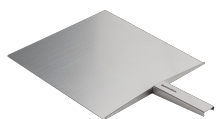

1PPZ



1CFFA

Related Products



1FICN9EI



1FICN9E