

# Vasca Quadra R. "0" da 40x40

incasso, filo e sottotop

1Q40401

## Descrizione



- acciaio inox AISI 304 di spessore elevato
- dimensione vasca: 40x40x21,5 h
- dotazioni: pilettone 3" ½, troppo-pieno con scarico perimetrale
- base inserimento vasca:
- - : 50
- - sottotop: 60
- incasso: 43,5x43,7 cm
- filotop e sottotop: v. scheda tecnica

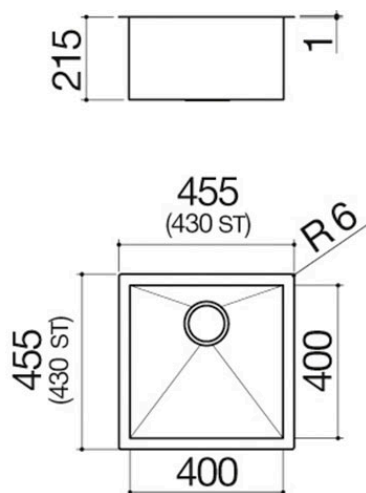

## Plus

### Dettaglio delle caratteristiche



Acciaio inox AISI 304

L'AISI 304, utilizzato per la realizzazione dei prodotti Barazza, è un acciaio inossidabile di alta qualità che garantisce resistenza alle sollecitazioni, durabilità nel tempo e facilità di pulizia.



Acciaio inox di spessore elevato

Barazza utilizza acciaio AISI 304 di spessore elevato, il quale è completamente riciclabile, resistente alla corrosione, durevole e altamente igienico.



Vasche capienti

I prodotti che riportano questo plus sono caratterizzati dalla presenza di vasche ampie e capienti, in grado di ospitare grandi volumi d'acqua e strumenti di cottura di grande dimensione.



Troppo-pieno con scarico perimetrale

Tutti i lavelli e le vasche Barazza sono dotati di troppo-pieno, dispositivo di sicurezza per evitare la fuoriuscita dell'acqua. Alcuni presentano la versione con scarico perimetrale, esteticamente distintiva.



Raggio 0

Raggiatura squadrata ed elegante.

# Installazioni

## Metodo di installazione

FT

Filotop



Conferisce un perfetto allineamento al top.

IBP

Incasso bordo piatto



Il bordo si avverte solo al tatto e rende facile l'installazione.

ST

Sottotop



Le vasche quadre sono elegantemente inserite al di sotto del piano di lavoro.

## Accessori correlati

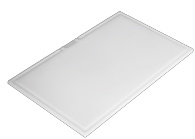

1TOF26



1VSOF



1VOF



1CIVQ



1CPI

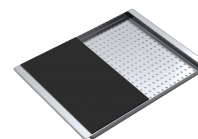

1CITN

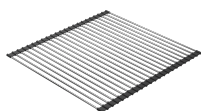

1GSPA

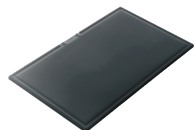

1TOF26N



1GLN

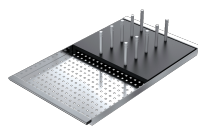

1CIFX



1QORN

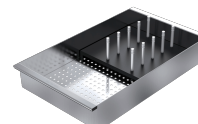

1VSFX



1SPR



1SPSN



1SPSI

## Prodotti correlati



1Q3440I



1Q3440S



1Q4040S



1Q5040I



1Q5040S