



50x40 cm Square Bowl R. "0"

built-in, flush

1Q5040I

Description

- extra-thick AISI 304
- stainless steel
- 50x40x21.5 h bowl
- equipment: 3½" basket strainer waste,
- perimeter overflow
- base unit for bowls:
 - - built-in and flush: 60
 - - undermounted: 75
- 53.5x43.7 cm cut out
- flush-top and undermounted: check technical sheet

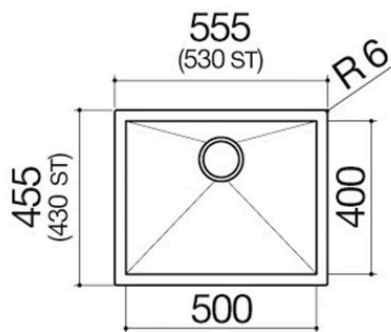



Plus

Detailed Features



AISI 304 stainless steel

Barazza products are made of high-quality AISI 304 stainless steel, which guarantees resistance to stress, long-lasting durability and ease of cleaning.



Extra-thick AISI 304 stainless steel

Barazza uses thick AISI 304 stainless steel, which is fully recyclable, corrosion-resistant, durable and highly hygienic.



Deep bowls

Products with this plus feature large, deep bowls capable of accommodating high volumes of water and large cookware.

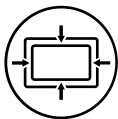

Perimeter overflow

All Barazza sinks and bowls are equipped with an overflow device that prevents water from spilling. Some versions feature a perimeter overflow, with an exclusive and refined design. Smart pop-up waste.



Radius 0

Squared and elegant bowl radius for a minimalist and contemporary look.



Installations

Installation Method

 FT

Flush-top



Ensures perfect alignment with the worktop

 FEB

Flat edge built-in



The edge is perceptible only to the touch and makes installation easy.

 UM

Undermounted



The square bowls are elegantly installed beneath the worktop.



Related Accessories

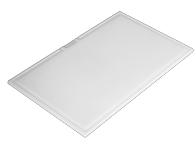

1TOF26



1VOF



1VSOF

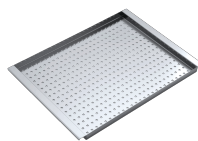

1CIVQ



1CPI

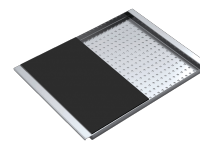

1CITN

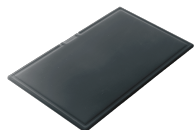

1TOF26N

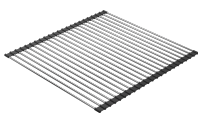

1GSPA

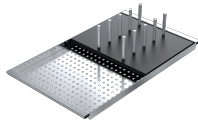

1CIFX



1VSFX

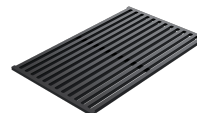

1GLN



1GQRN



1SPR



1SPSI



1SPSN

Related Products



1Q3440I



1Q3440S



1Q4040I



1Q4040S



1Q5040S