

Vasca Quadra R. "0" da 50x40

incasso, filo e sottotop

1Q5040I

Descrizione



- acciaio inox AISI 304 di spessore elevato
- dimensione vasca: 50x40x21,5 h
- dotazioni: pilettone 3" ½, troppo-pieno con scarico perimetrale
- base inserimento vasca:
- - : 60
- - sottotop: 75
- incasso: 53,5x43,7 cm
- filotop e sottotop: v. scheda tecnica

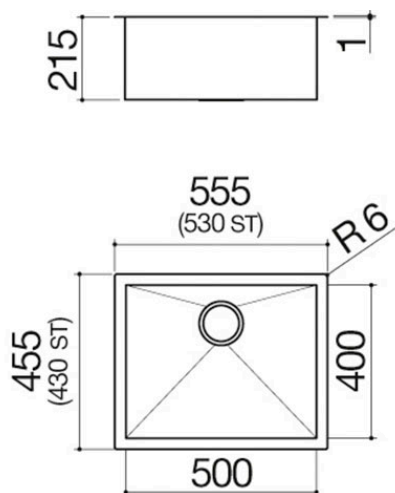

Plus

Dettaglio delle caratteristiche



Acciaio inox AISI 304

L'AISI 304, utilizzato per la realizzazione dei prodotti Barazza, è un acciaio inossidabile di alta qualità che garantisce resistenza alle sollecitazioni, durabilità nel tempo e facilità di pulizia.



Acciaio inox di spessore elevato

Barazza utilizza acciaio AISI 304 di spessore elevato, il quale è completamente riciclabile, resistente alla corrosione, durevole e altamente igienico.



Vasche capienti

I prodotti che riportano questo plus sono caratterizzati dalla presenza di vasche ampie e capienti, in grado di ospitare grandi volumi d'acqua e strumenti di cottura di grande dimensione.



Troppo-pieno con scarico perimetrale

Tutti i lavelli e le vasche Barazza sono dotati di troppo-pieno, dispositivo di sicurezza per evitare la fuoriuscita dell'acqua. Alcuni presentano la versione con scarico perimetrale, esteticamente distintiva.



Raggio 0

Raggiatura squadrata ed elegante.

Installazioni

Metodo di installazione

FT

Filotop

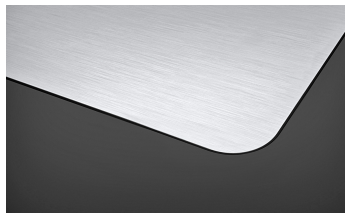

Conferisce un perfetto allineamento al top.

IBP

Incasso bordo piatto



Il bordo si avverte solo al tatto e rende facile l'installazione.

ST

Sottotop

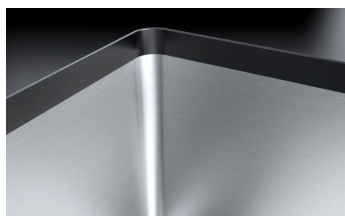

Le vasche quadre sono elegantemente inserite al di sotto del piano di lavoro.

Accessori correlati



1TOF26



1VSOF



1VOF

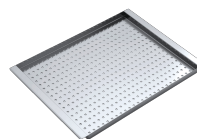

1CIVQ



1CPI

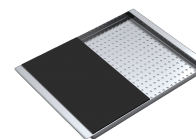

1CITN

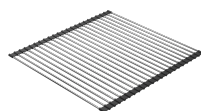

1GSPA

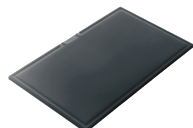

1TOF26N



1GLN

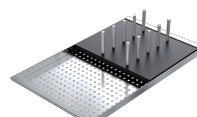

1CIFX



1QORN

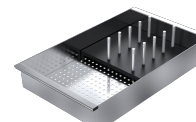

1VSFX



1SPR



1SPSN



1SPSI

Prodotti correlati



1Q3440I



1Q3440S



1Q4040I



1Q4040S



1Q5040S