

Vasca Quadra R."12" 316 da 50x40

incasso, filo e sottotop

1QR506

Descrizione



- acciaio inox AISI 316 di spessore elevato
- dimensione vasca: 50x40x20 h
- dotazioni: pilettoni 3" 1/2, troppo-pieno B
- base inserimento vasca:
- - incasso e filo: 60
- - sottotop: 80
- incasso: 52x42 cm
- + intaglio per troppo-pieno
- filotop e sottotop: v. scheda tecnica

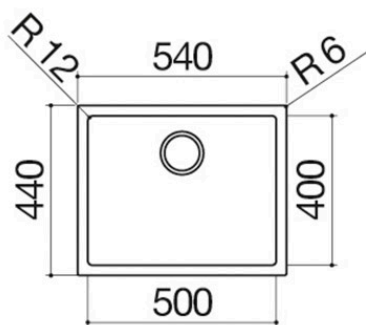
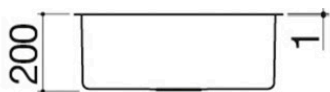

Plus

Dettaglio delle caratteristiche



Acciaio inox di spessore elevato

Barazza utilizza acciaio AISI 304 di spessore elevato, il quale è completamente riciclabile, resistente alla corrosione, durevole e altamente igienico.



Vasche capienti

I prodotti che riportano questo plus sono caratterizzati dalla presenza di vasche ampie e capienti, in grado di ospitare grandi volumi d'acqua e strumenti di cottura di grande dimensione.



Raggio 12

Raggiatura dallo spigolo leggermente raccordato.



Acciaio inox AISI 316

Elementi realizzati in acciaio inox AISI 316, un materiale completamente riciclabile, durevole e altamente igienico, estremamente resistente agli agenti atmosferici e alla salsedine.

Installazioni

Metodo di installazione

FT

Filotop



Conferisce un perfetto allineamento al top.

IBP

Incasso bordo piatto



Il bordo si avverte solo al tatto e rende facile l'installazione.

ST

Sottotop



Le vasche quadre sono elegantemente inserite al di sotto del piano di lavoro.

Accessori correlati



1TOF26



1VSOF



1VOF

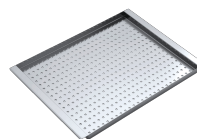

1CIVQ

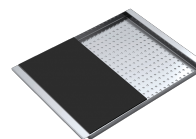

1CITN

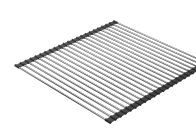

1GSPA

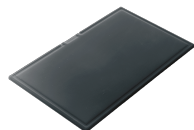

1TOF26N

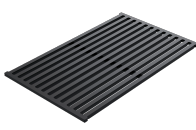

1GLN

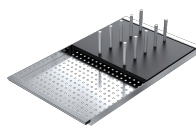

1CIFX

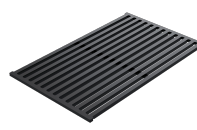

1GQRN



1VSFX

Prodotti correlati



1LLB616



1LLB916



1LLB606



1QR406



1QR706