



# 70x40 cm Square Bowl R."12" 316

**built-in, flush and undermounted**

1QR706

## Description



- extra-thick AISI 316 stainless steel
- 70x40x20 h bowl
- equipment: 3½" basket strainer waste,
- B overflow
- base unit for bowls:
  - - built-in and flush: 80
  - - undermounted: 90
- 72x42 cm cut out
- + notch for overflow
- flush-top and undermounted: check technical sheet

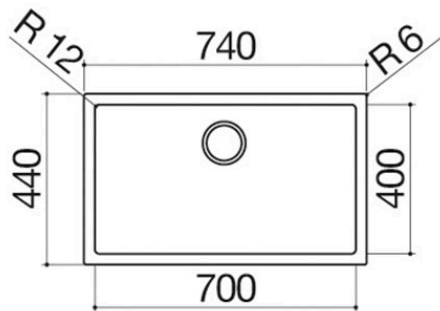
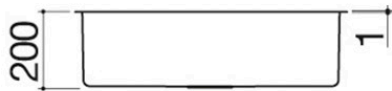



## Plus

### Detailed Features



Extra-thick AISI 304 stainless steel

Barazza uses thick AISI 304 stainless steel, which is fully recyclable, corrosion-resistant, durable and highly hygienic.



Deep bowls

Products with this plus feature large, deep bowls capable of accommodating high volumes of water and large cookware.



Radius 12

Radius with a slightly rounded edge.



AISI 316 stainless steel

Elements made of AISI 316 stainless steel, a fully recyclable, durable and highly hygienic material, extremely resistant to weather and salt.



# Installations

## Installation Method



Flush-top



Ensures perfect alignment with the worktop



Flat edge built-in



The edge is perceptible only to the touch and makes installation easy.



Undermounted



The square bowls are elegantly installed beneath the worktop.



## Related Accessories

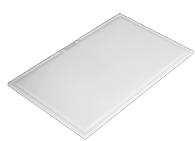

1TOF26



1VOF



1VSOF



1CIVQ

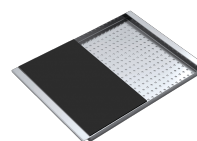

1CITN

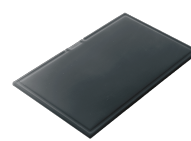

1TOF26N

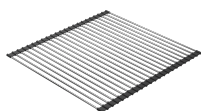

1GSPA

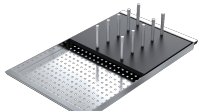

1CIFX

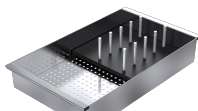

1VSFX



1GLN



1GQRN

## Related Products



1LLB616



1LLB916



1LLB606



1QR406



1QR506