



Cuve Carré R. « 12 » 316 de 70x40 à encastrement, au ras du plan et sous plan

1QR706

Description



- acier inox AISI 316 de forte épaisseur
- dimensions de la cuve : 70x40x20 h
- équipement : bonde 3" 1/2, trop-plein B
- base pour insertion cuve :
- - encastrement et au ras du plan : 80
- - sous plan : 90
- encastrement : 72x42 cm + découpe pour trop-plein
- au ras du plan et sous le plan de travail : voir fiche technique

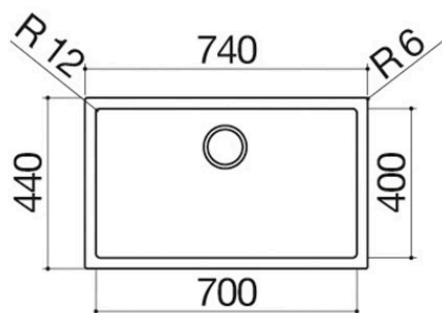
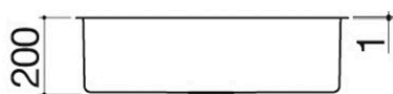



Plus

Caractéristiques détaillées



Acier inox de forte épaisseur

Barazza utilise de l'acier AISI 304 de forte épaisseur, entièrement recyclable, résistant à la corrosion, durable et hautement hygiénique.



Grandes cuves

Les produits qui reportent ce plus sont caractérisés par la présence de cuves amples et grandes, en mesure d'accueillir de grands volumes d'eau et des instruments de cuisson de grande dimension.



Rayon 12

Rayon avec arête légèrement raccordée.



Acier inox AISI 316

Éléments réalisés en acier inox AISI 316, un matériau entièrement recyclable, durable et hautement hygiénique, extrêmement résistant aux agents atmosphériques et à la salinité.



Installations

Méthode d'installation

 RP

Au ras du plan



Il donne un alignement parfait au plan de travail.

 EBP

Encastrement bord plat



Le bord n'est perceptible qu'au toucher et facilite l'installation.

 SP

Sous plan de travail



Les cuves carrées sont élégamment insérées sous le plan de travail.



Accessoires associés

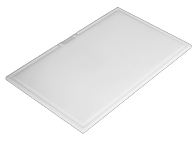

1TOF26



1VOF



1VSOF



1CIVQ

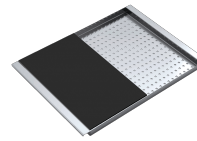

1CITN

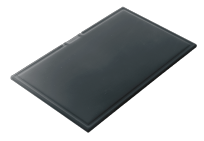

1TOF26N

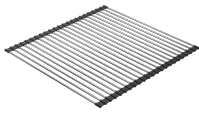

1GSPA

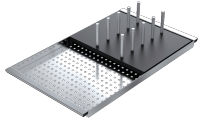

1CIFX



1VSFX



1GLN



1GQRN

Produits similaires



1LLB616



1LLB916



1LLB606



1QR406



1QR506