

1X4540I

Rev.2

DESCRIZIONE Vasca quadra raggio "15" incasso e filo da 45x40
DESCRIPTION 45x40 cm built-in and flush square bowl with radius "15"

PESO LORDO 6.8 Kg
GROSS WEIGHT

DIMENSIONI IMBALLO 595x495x270 mm
PACKAGING DIMENSIONS

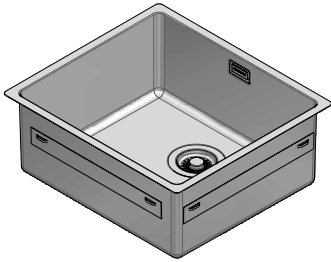

! E' NECESSARIO FARE UNO SCANSO NEL TOP IN CORRISPONDENZA DEL TROPPOPIENO
 YOU SHOULD MAKE A SLOT IN THE TOP WHERE THE OVERFLOW IS INSTALLED

- Acciaio inox AISI 304 di spessore elevato (AISI 304 extra thick stainless steel)
- Dimensione vasca: 45x40x19,5 h (Bowl dimensions: 45x40x19,5 h cm bowl)
- Dotazioni: pilettona 3"1/2, troppo-pieno con scarico perimetrale (Equipment: 3.5" basket strainer waste, perimeter overflow) (A)
- Base per inserimento vasca: 60 cm (Base unit for bowl: 60 cm)
- Incasso: 47x42 cm + intaglio per troppo-pieno (Built-in: 47x42 cm cut out + notch for overflow)
- Filotop: 49,3x44,3 cm (Flush: 49,3x44,3 cm)

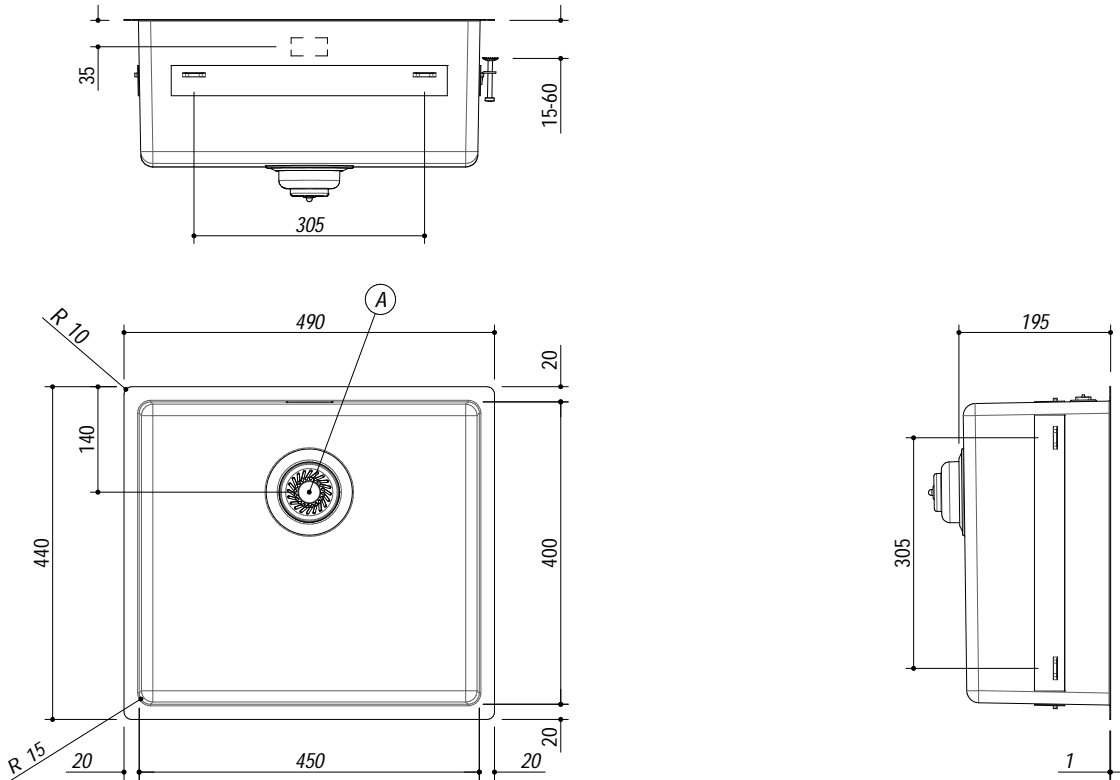

SCALA DISEGNO 1:10
DRAWING SCALE



TUTTE LE MISURE IN mm
ALL MEASURES IN mm

TOLLERANZA LINEARE: ± 0.5 mm
LINEAR TOLERANCE

TOLLERANZA ANGOLARE: ± 0.2 °
ANGULAR TOLERANCE

FORATURA PER INSTALLAZIONE AD INCASSO
BUILT-IN CUTOUT FOR TOP

*** SCANSO NEL TOP PER IL TROPPOPIENO**
*** SLOT IN THE TOP FOR THE OVERFLOW**

FORATURA PER INSTALLAZIONE A FILO
FLUSH CUTOUT FOR TOP

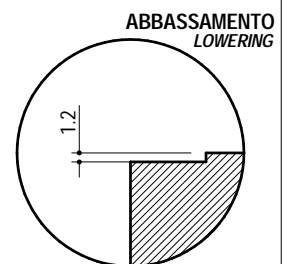
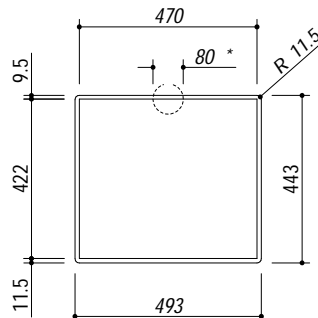
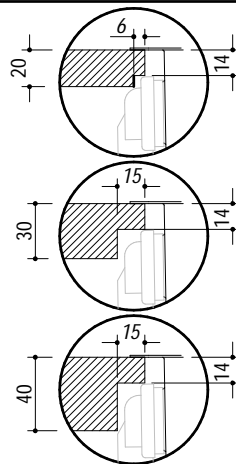
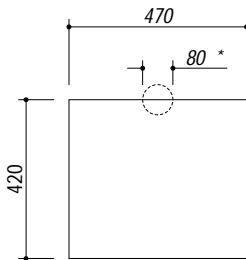

1:20

1:20